

A-A'

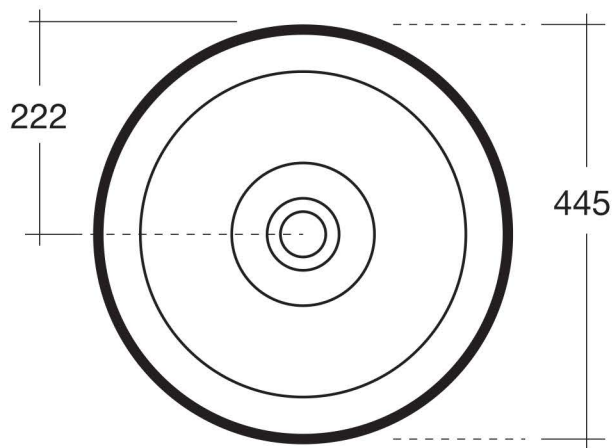

TOP

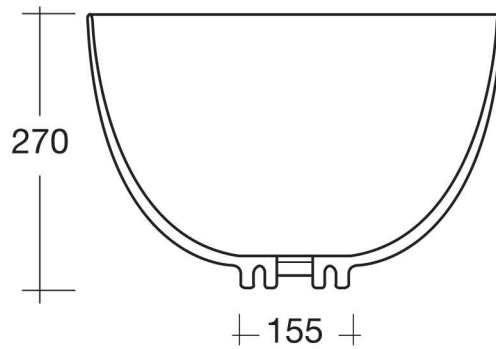

SECT A-A'

W030701