

A-A'

TOP

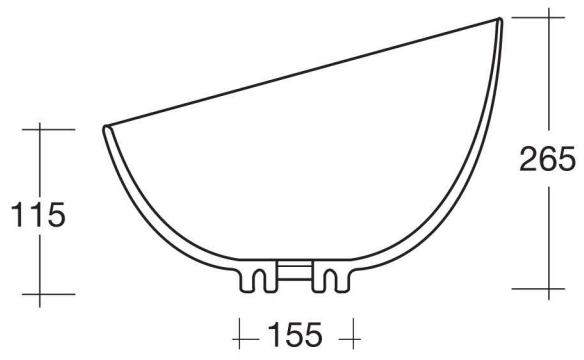

SECT A-A'

W031701