

# DUSCHPLAN

- a classic among shower trays
- modern, clear design only 65 mm deep
- available in rectangular or square design
- made of KALDEWEI steel enamel
- flush-fitting recessed waste cover  
(only in combination with the KA 90 waste fittings)



Similar illustration

	Combined Tray & Waste depth	Waste fitting depth
KA 90	145	81
KA 90 extra flat	134	70
KA 90 ultra flat	125	61
KA 90 vertical	49	81

See page 291.

Illustration shows Model 545-2

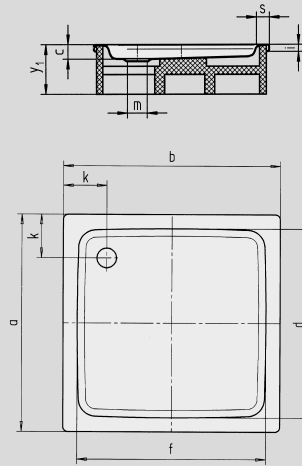
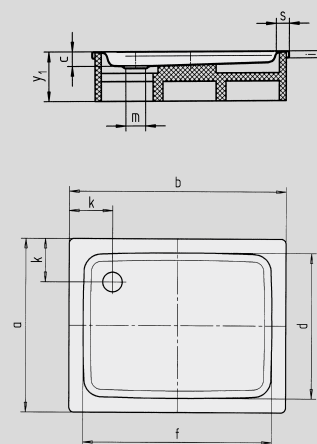

Illustration shows Model 546-2



Model No.		416	546	418
External length	a	750	800	900 mm
External width	b	1000	1000	1000 mm
Depth	c	65	65	65 mm
Internal length	d	620	670	770 mm
Internal width	f	870	870	870 mm
Height of rim	i	32	32	32 mm
Distance bath edge to centre of drain hole	k	200	200	200 mm
Diameter of drain hole	m	90	90	90 mm
Width of rim	s	65	65	65 mm
Height with support	y <sub>1</sub>	160	160	160 mm
Weight of the enamelled shower tray in kg		22	23	26
Anti-slip		∅ 435	∅ 588	∅ 588 mm